

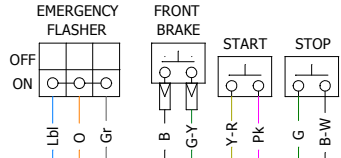

**RIGHT HANDLEBAR SWITCH**

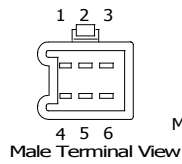

Note: All connectors shown are harness side



Male Terminal View

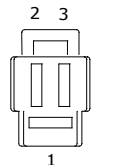

Female Terminal View

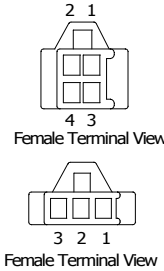

Female Terminal View

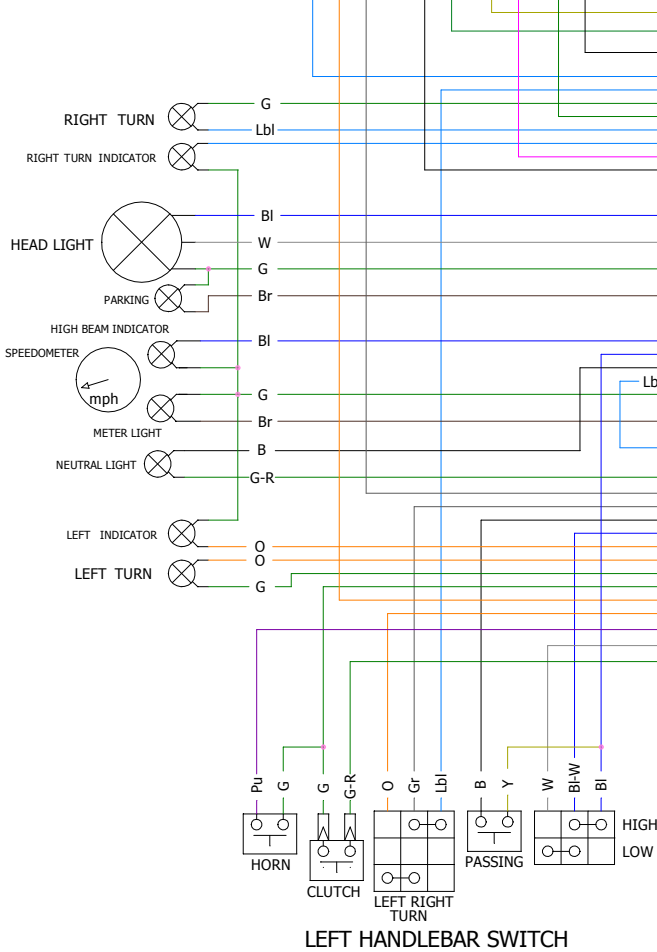

**LEFT HANDLEBAR SWITCH**



HORN

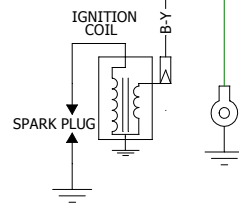

SPARK PLUG

IGNITION COIL

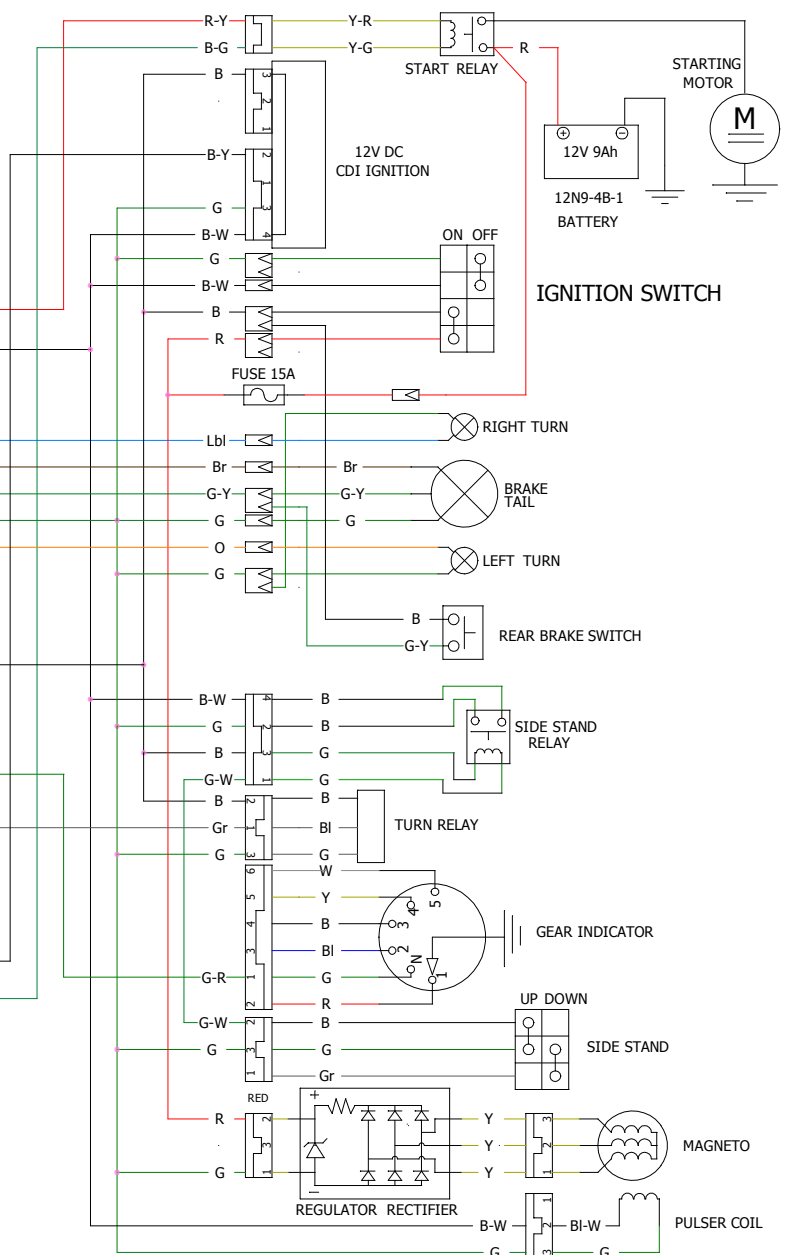

# Wire Harness Heist 250

Always On Headlight (Emergency Flasher)



REVISION  
0

10/5/2017